



INCIZO PROFILE

Technical data sheet
English

QUICK-STEP[®]
FLOOR DESIGNERS

General information

Multifunctional and patented profile to finish your floor and stairs in matching colours. Simply cut the Incizo basic profile to the desired shape with the supplied Incizo knife.

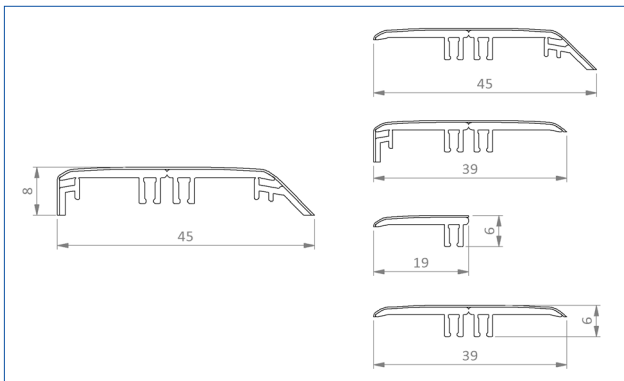

Contents

Composition

Colour

Incizo profile

PVC with decor foil on top

Colour matched

Multifunctional rail

PVC

Black

Incizo knife

Plastic holder with brown sanding paper and metal knife inside holder

Blue

Order code

Dimensions

QSVINCP(-)

2000 x 45 x 8 mm

Applicable for:

All Alpha Vinyl floors.

The floor must be able to expand and contract on all sides. This is why an expansion gap must be provided on all sides of the floor, around pipes, thresholds and under door frames. The exact expansion joint size depends on the floor type. Consult the installation instructions of your Quick-Step floor to know the required size of the expansion gap. To finish off this gap, we offer a wide range of skirting and profiles.

Applications

With the Incizo 5 in 1 profile, you can finish your floor in every situation.

1. Expansion profile

Connect two floors of the same height: in doorways, L-shaped rooms, or rooms where the floor length or width is greater in distance than 12m.



2. Adapter profile

Connect two floors of different heights. Make the transition from your vinyl floor to a floor covering at lower height, like tiles.



3. End profile

Finish your floor along walls, windows, sliding doors, a slightly higher doorstep or tile floor.



4. Transition profile

Create a nice transition between your vinyl floor and other flooring types, like a fixed carpet.



5. Stair profile

Cover your stairs or steps with Quick-Step planks, in combination with the Incizo profile as a stairnose. In this case, an aluminium subprofile (NEVINCPBASE(-)) for application on stairs is needed, to be ordered separately.



Please refer to the technical data sheet of the Incizo stairs to learn more about installation as a stair profile.

Features

Quick-Step accessories are specifically developed for Quick-Step floors.

✓ **Perfectly matching colour**

The Quick-Step Incizo profile is available in a design that matches your floor perfectly.

✓ **Excellent wear- and scratch resistant surface**

The durable toplayer makes the Incizo profile resistant to scratches and wear.

✓ **Quick-Step warranty**

Profiles come with the same warranty as your floor.

✓ **Easy to install**

Easy installation with the included rail, to be glued with the Quick-Step One4All Glue (QSG LUE290).

✓ **Complete package**

The rail and the Incizo knife are supplied together with the Incizo profile.



Preparation

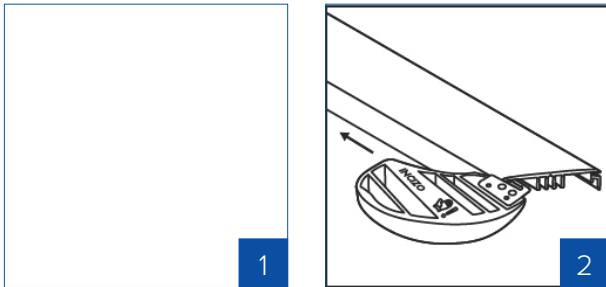

1. **Always wear gloves - the edge of the profile and the blade are sharp. Read the instructions carefully before use.**
2. The Incizo slitter can be used very simply to cut the profile to the desired profile shape. When cutting the profile, always lay it horizontally on a stable surface.

Installation

Expansion profile

An expansion profile connects two floors of the same height.

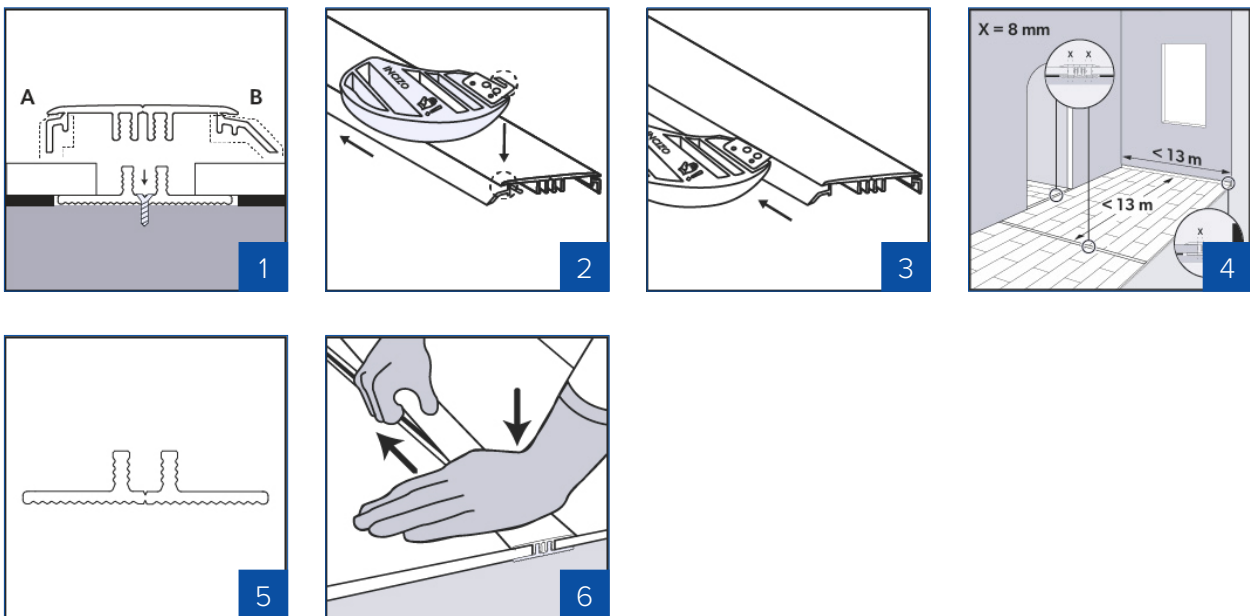

1. First saw the Incizo profile to the correct length. Then use the supplied Incizo knife to cut away piece A and piece B to obtain an expansion profile. **Tip: for easy cutting, cut both lengths first before removing the 2 pieces.**
2. Place the slitter so that the blade fits into the narrow slit in the profile.
3. Gently slide it in the direction of the arrow, making sure not to cut into the PVC base. Take off the pieces to be removed.
4. While installing the floor, be sure to allow sufficient space between the two surfaces that will be joined with the profile. Mark the ground to indicate how far the edge of the floor will extend. Allow the underlay to extend to just before this line; it is better to fit the rail later directly on the subfloor.
Cut the plastic rail to the correct length and place it in the middle of the open space between

the two floor surfaces. Ensure that there is a sufficient expansion gap between the floor and the raised legs of the rail, in which the profile will be clamped.

5. The rail can be installed with the Quick-Step One4All Glue (QSG LUE290) to any type of surface. Or it can be attached with screws: Use the pre-drilled holes between the raised legs of the rail. Be careful not to screw into any pipes or cables.
6. Gently press the profile from one side of the rail to the other. Press against the floor.

Adapter profile

An adapter profile connects two floors of different heights.

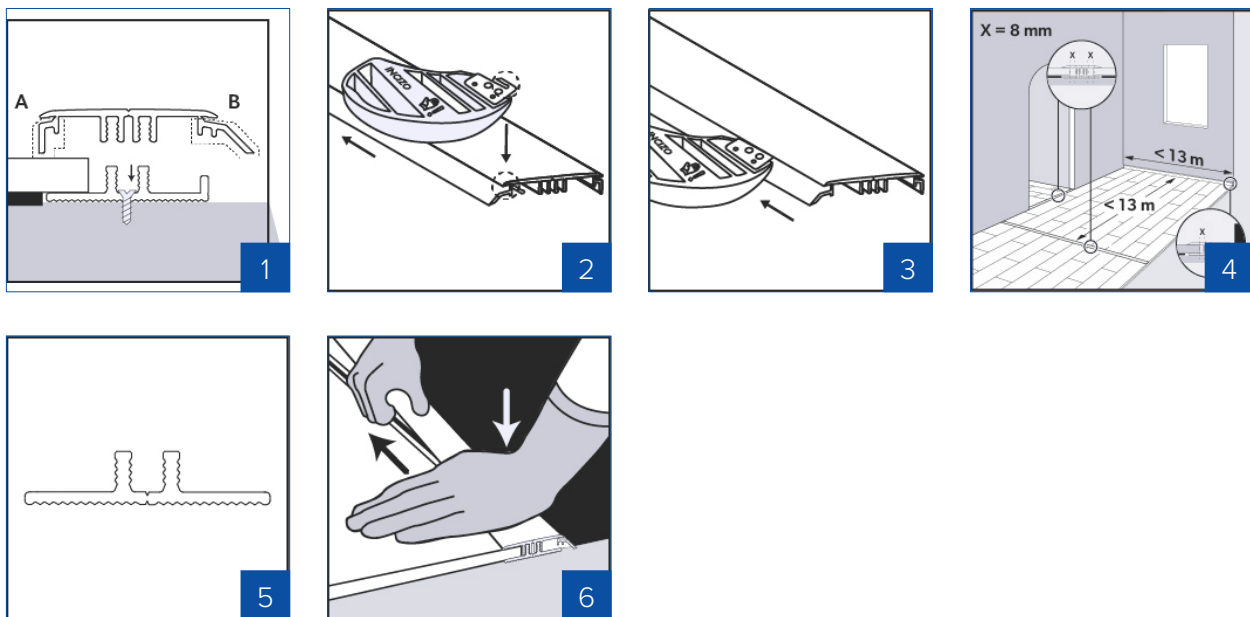

1. First saw the Incizo profile to the correct length. Then use the supplied Incizo knife to cut away piece A to obtain an adapter profile.
2. Place the slitter so that the blade fits into the narrow slit in the profile.
3. Gently slide it in the direction of the arrow, making sure not to cut into the PVC base. Take off the pieces to be removed.
4. While installing the floor, be sure to allow sufficient space between the two surfaces that will be joined with the profile. Mark the ground to indicate how far the edge of the floor will extend. Allow the underlay to extend to just before this line; it is better to fit the rail later directly on the subfloor.
Cut the plastic rail to the correct length and place it in the middle of the open space between the two floor surfaces. Ensure that there is a sufficient expansion gap between the floor and the raised legs of the rail, in which the profile will be clamped.

5. The rail can be installed with the Quick-Step One4All Glue (QSG LUE290) to any type of surface. Or it can be attached with screws: Use the pre-drilled holes between the raised legs of the rail. Be careful not to screw into any pipes or cables.
6. Gently press the profile from one side of the rail to the other. Press against the floor.

End profile

An end profile is used to finish your floor along walls or windows.

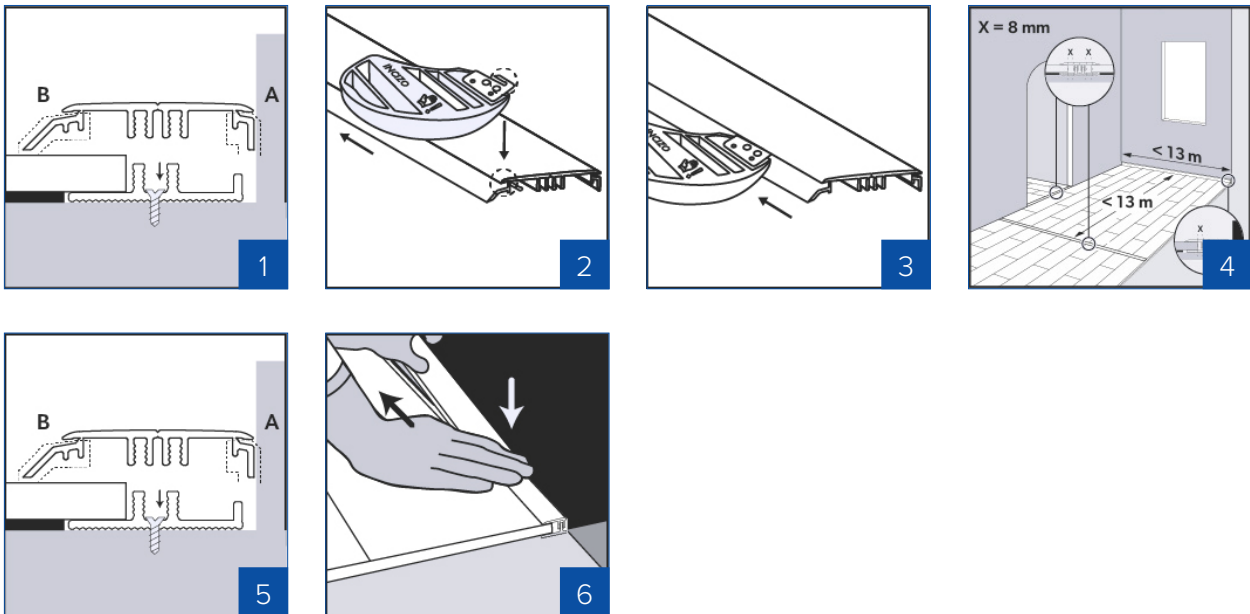

1. First saw the Incizo profile to the correct length. Then use the supplied Incizo knife to cut away piece B to obtain an adapter profile.
2. Place the slitter so that the blade fits into the narrow slit in the profile.
3. Gently slide it in the direction of the arrow, making sure not to cut into the PVC base. Take off the pieces to be removed.
4. While installing the floor, be sure to allow sufficient space between the two surfaces that will be joined with the profile. Mark the ground to indicate how far the edge of the floor will extend. Allow the underlay to extend to just before this line; it is better to fit the rail later directly on the subfloor.
Cut the plastic rail to the correct length and place it in the middle of the open space between the two floor surfaces. Ensure that there is a sufficient expansion gap between the floor and the raised legs of the rail, in which the profile will be clamped.

5. The rail can be installed with the Quick-Step One4All Glue (QSG LUE290) to any type of surface. Or it can be attached with screws: Use the pre-drilled holes between the raised legs of the rail. Be careful not to screw into any pipes or cables.
6. Gently press the profile from one side of the rail to the other. Press against the floor.

Transition profile

A transition profile is used to create a nice transition between your vinyl floor and other flooring types like a fixed carpet.

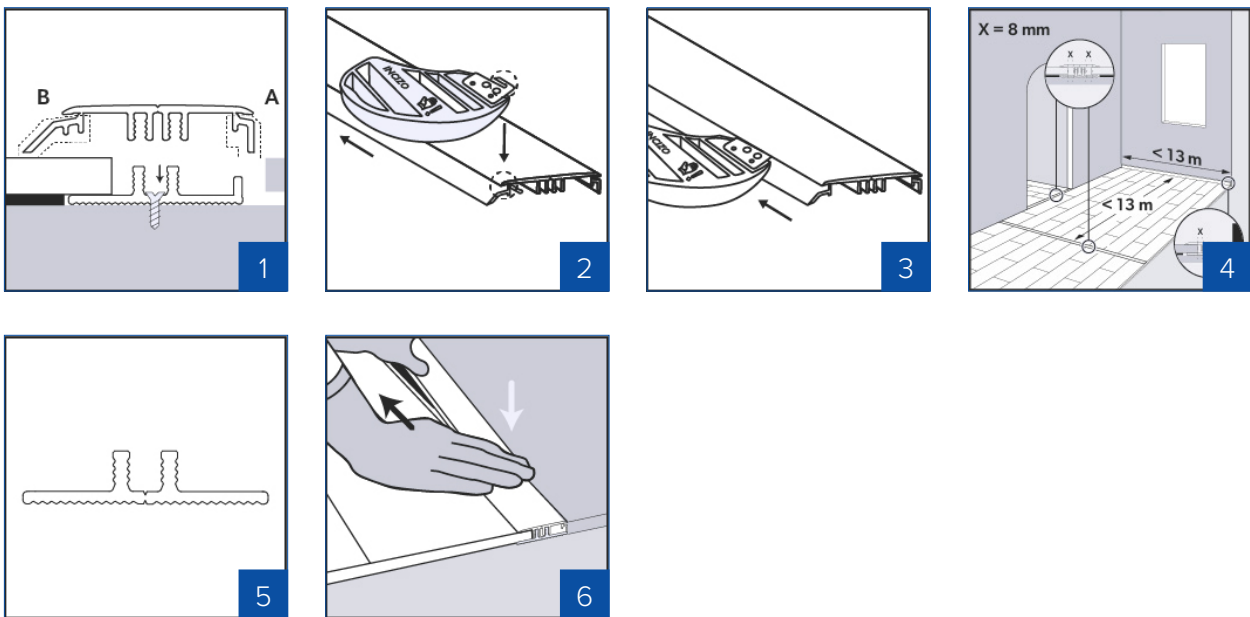

1. First saw the Incizo profile to the correct length. Then use the supplied Incizo knife to cut away piece B to obtain an adapter profile.
2. Place the slitter so that the blade fits into the narrow slit in the profile.
3. Gently slide it in the direction of the arrow, making sure not to cut into the PVC base. Take off the pieces to be removed.
4. While installing the floor, be sure to allow sufficient space between the two surfaces that will be joined with the profile. Mark the ground to indicate how far the edge of the floor will extend. Allow the underlay to extend to just before this line; it is better to fit the rail later directly on the subfloor.
Cut the plastic rail to the correct length and place it in the middle of the open space between the two floor surfaces. Ensure that there is a sufficient expansion gap between the floor and the raised legs of the rail, in which the profile will be clamped.

5. The rail can be installed with the Quick-Step One4All Glue (QSG LUE290) to any type of surface. Or it can be attached with screws: Use the pre-drilled holes between the raised legs of the rail. Be careful not to screw into any pipes or cables.
6. Gently press the profile from one side of the rail to the other. Press against the floor.

Stairnose

The Incizo profile can also be used to finish your stairs and steps.

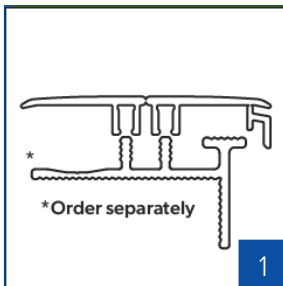

1. For installation of the Incizo profile on stairs or steps, an aluminium subprofile is needed. This subprofile is to be ordered separately (NEVINCPBASE(-)). Do not use the plastic rail included in the Incizo packaging.
Please refer to the technical data sheet of Incizo stairs to learn more about installation as a stair profile.

